



**IEC**

**NEC**

**CLASSIFICATION  
COMPARATOR**

## THE IEC/NEC® COMPARATOR

World standards for the classification of hazardous areas are moving toward harmonization. The 1999 U.S. National Electric Code (NEC®) and the 1998 Canadian Electric Code (CEC®) now recognize the use of the Zone system for classification of hazardous areas. Whereas it would appear these moves would bring a degree of “harmonization” of world standards, in fact this is just a first step toward that goal.

Much has been written and published about Article 505 in the 1999 NEC®. Now as a stand-alone article it basically has created an Americanized version of the IEC/CENELEC Zone system. It uses the familiar Class/Division system and fits the IEC European Zones into it while maintaining NEC® wiring methods and protection techniques. A distinction must be made between the U.S. Zone system and the IEC/CENELEC Zone system. They are not the same. Similar—yes, the same—no.

The Class/Division system for hazardous areas is so ingrained in the U.S. electrical culture that learning and using the Zone system will take some time. But it will happen. There are some advantages to products specifically designed for use in zone designated areas. Since most of the world (except the U.S.) uses the IEC (or a local variation of it) understanding it would seem to be very important.

To understand where we are now with “zones” really requires a basic understanding of how we got here. The following pages are presented as a short overview of European IEC principles, protection methods, products, terminology, comparisons to NEC® and CEC standards, differences in world installation practices, and a glossary of terms. We hope it will give the reader a clearer view of the IEC approach to safety in hazardous location “protection” and how it compares to the NEC®.

## WORLD STANDARDS

It is generally accepted that electrical equipment for explosive atmospheres are covered by 4 major world standards.

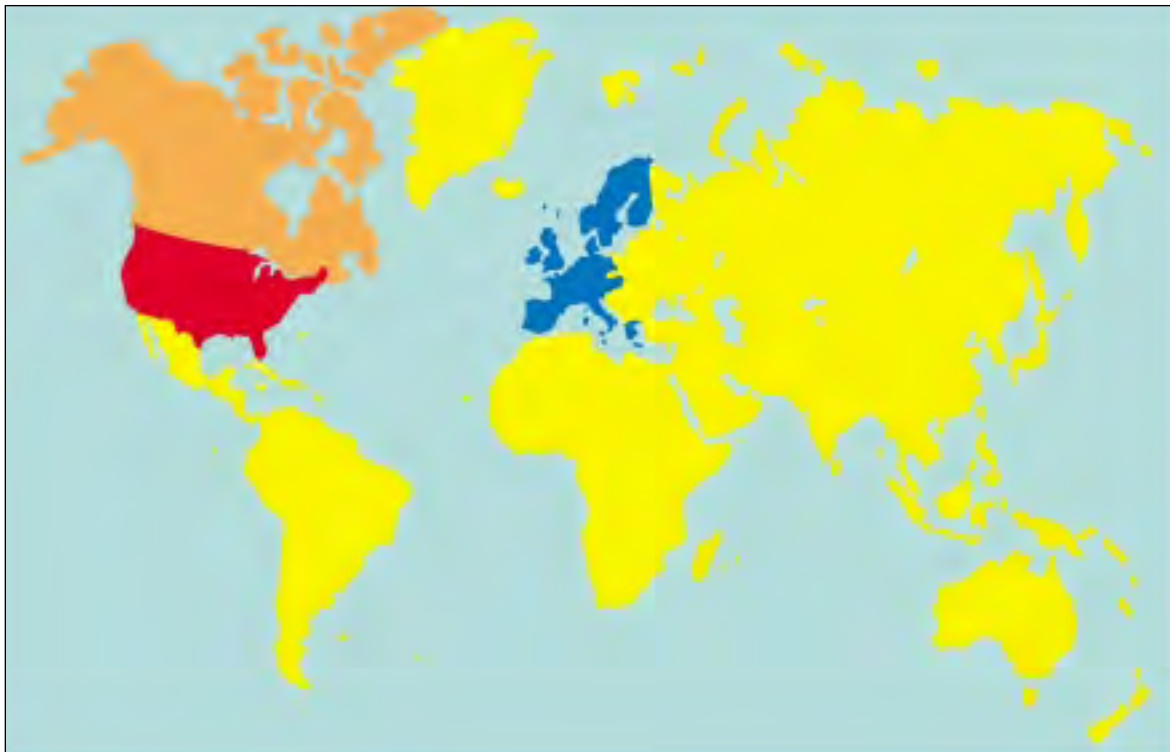

**Red** NEC® Compulsory    **Orange** CEC Compulsory    **Blue** CENELEC Compulsory    **Yellow** A number of admissible standards (IEC, CENELEC, NEC®, others)

Copyright ©2000 EGS/Appleton Electric®

## WHAT IS A ZONE?

THE IEC HAS DEFINED 3 AREAS OF HAZARDOUS GAS OR VAPOR RELEASE AS FOLLOWS:

ZONE 0	ZONE 1	ZONE 2
<p><b>Explosive Atmosphere Is Continuously Present</b></p> <p>Zone in which an explosive mixture of gas, vapor or mist is continuously present.</p>	<p><b>Explosive Atmosphere Is Often Present</b></p> <p>Zone in which an explosive mixture of gas, vapor or mist is likely to occur during normal operation.</p>	<p><b>Explosive Atmosphere May Accidentally Be Present</b></p> <p>Zone in which an explosive mixture is not likely to occur in normal operation, and if it occurs will only exist for a short time (leaks or maintenance).</p>

## COMPARING IEC ZONES AND NEC® DIVISIONS

Z O N E 0	ZONE 1	ZONE 2
	DIVISION 1	DIVISION 2

## DETERMINING A "ZONE" REQUIRES ANSWERING 4 ESSENTIAL QUESTIONS



1

What is emission level of gas/vapor?

- (a) continuous, (b) first level emission, (released during normal operation)
- (c) second level emission (released during abnormal operation)



2

What type of openings currently exist?

- (a) continuously open, (b) normally closed,
- (c) weatherproof, (d) emergency open only



3

What is ventilation?

- (a) very good, (b) good, (c) poor



4

What is level of ventilation?

- (a) high, (b) average, (c) weak



## EXAMPLES OF ZONE CLASSIFICATION SITUATIONS

ZONE 0

ZONE 1

ZONE 2

NON HAZARDOUS ZONE

### EXAMPLE 1

#### CONDITIONS:

- ① All manual ventilation
  - ② Zone 0 area
  - ③ Zone 1 area
  - ④ Non hazardous area
- Open air mixing tank
  - No mechanical ventilation
  - Products stored in work area

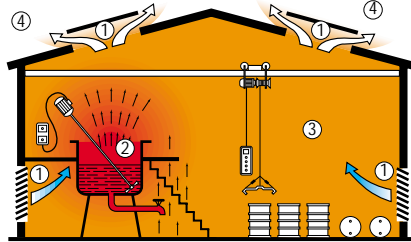

### EXAMPLE 2

#### CONDITIONS:

- ① Hood over tank
- ② Zone 0 area
- ③ Zone 1 area
- ④ Zone 2 area
- ⑤ Non hazardous area
- ⑥ Mechanical ventilation
- ⑦ Stored products separated from work area

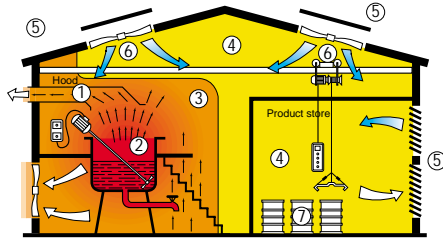

### EXAMPLE 3

#### CONDITIONS:

- ① Tank closed
  - ② Mechanical ventilation
  - ③ Zone 0
  - ④ Zone 2
  - ⑤ Non hazardous area
- Operations control outside zones

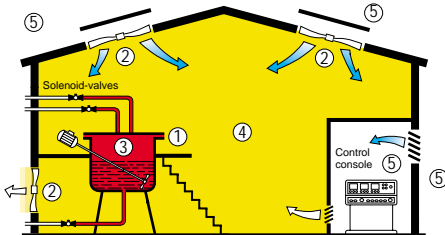

## EXAMPLES OF CLASS I, DIVISION 1 AND 2 SITUATIONS

CLASS I, DIVISION 1

CLASS I, DIVISION 2

NON CLASSIFIED

### EXAMPLE 1

#### CONDITIONS:

- ① Class I, Division 1 hazard exists during normal operation conditions
- Open air mixing tank
  - Products stored in work area
- ② Area classified based on properties of vapors present
  - ③ Electrical equipment must use approved Div. 1 NEC® protection techniques and wiring methods

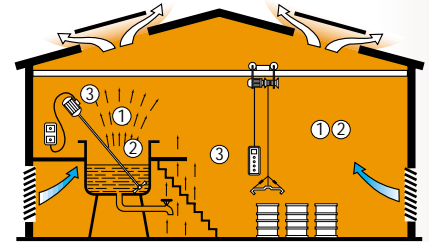

### EXAMPLE 2

#### CONDITIONS:

- ① Division 2 area can exist where vapors are normally in closed system or containers
  - ② Division 1 and 2 areas separated by barrier or space (transition zone)
- Hazardous areas properly documented
  - Div. 2 must use approved NEC® wiring methods and products
- ③ Stored products outside Div. 1 work area
  - ④ Non hazardous area

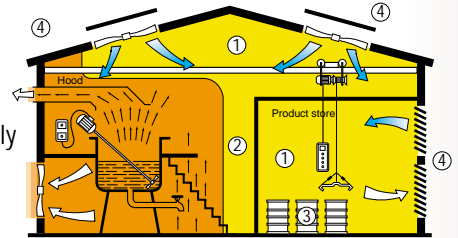

### EXAMPLE 3

#### CONDITIONS:

- ① Closed tank and piping confines Div. 1
- ② Yellow area qualifies as Div. 2
- ③ Stored products not present
- ④ Purged/pressurized control room qualifies as "non hazardous" is sealed off from Div. 2 area
- ⑤ Electrical equipment in Div. 2 must use approved Div. 2 protection techniques and products

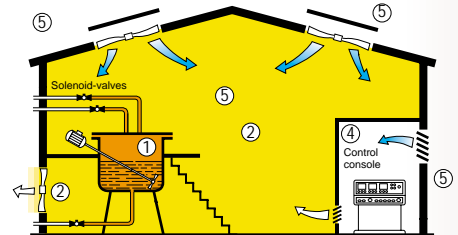

# INSTALLATION METHODS USED THROUGHOUT THE WORLD

## CONDUCTORS IN RIGID CONDUIT

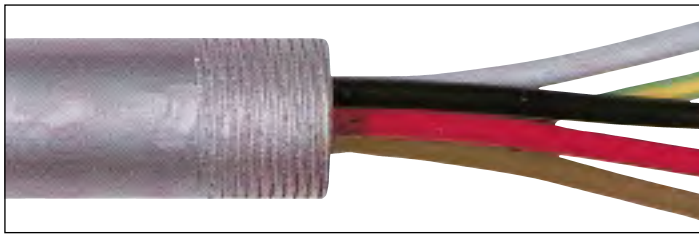

### WHERE USED:

United States, Canada, parts of South America, Middle East, Far East, other NEC® areas

### COMMENTS:

- Excellent protection against mechanical and chemical attack, and fire
- Seals as required by NEC®
- Easy to add new conductors

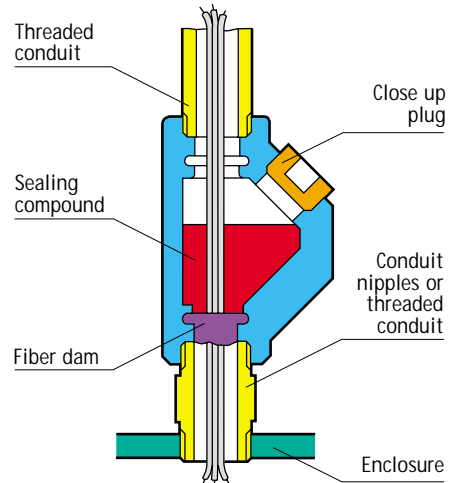

## ARMORED CABLE



### WHERE USED:

United Kingdom, Commonwealth countries, Spain

### COMMENTS:

- Good mechanical protection, positive grounding
- Requires special care to install cable gland and insure ground

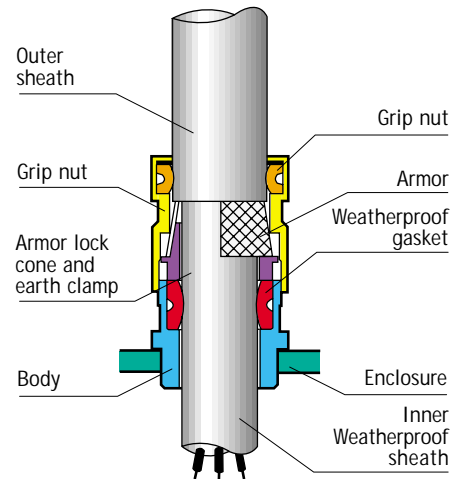

## NON ARMORED CABLE



### WHERE USED:

France, Germany, Italy, Eastern European countries, part of Africa, Middle East, Far East

### COMMENTS:

- Economical, flexible and fast
- Subject to mechanical abuse.

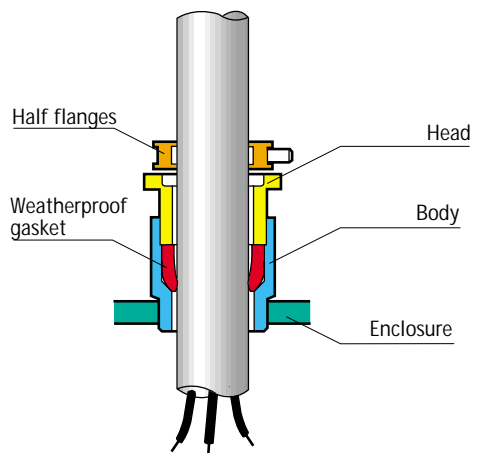

# MORE ON CABLE TYPES

## NON ARMORED CABLE TYPES (UNARMORED), SINGLE SHEATH

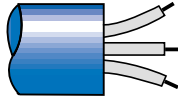

**COMMENTS:**

Economical. Use in Zone 2 and some ZONE 1. Uses waterproof polyamide cable gland.

## ARMORED CABLE TYPES

**STEEL TAPE ARMOR**  
(Without lead sheath)  
(STA)

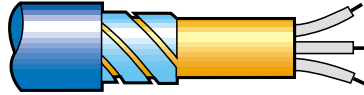

**COMMENTS:**

Has exterior neoprene jacket. Steel tape surrounds inner jacket with conductors for maximum protection. Popular in oil industry. Commonly buried.

**STEEL TAPE**  
(with lead sheath)  
(LWA)

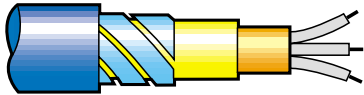

**COMMENTS:**

Has exterior neoprene jacket. Steel tape surrounds lead sheath for maximum protection. Popular in oil industry. Commonly buried.

**STEEL WIRE**  
Braided  
(GSWB)



**COMMENTS:**

Conductors are wrapped in an exterior neoprene jacket. Conductors surrounded by a metallic sheath or steel braid. Very flexible, for instrumentation and/or shielding applications.

**STEEL WIRE**  
Armored  
(SWA)

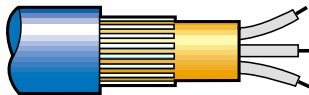

**COMMENTS:**

Has exterior neoprene jacket. Conical shaped steel wires protect inner jacket and conductors. High strength and durable.

## POPULAR CABLE TYPES‡ FOR CLASSIFIED AREAS

Cable Type	NEC Class I, Div. 1 and Zone 1	NEC Class I, Div. 2 and Zone 2	IEC Zone 1 and Zone 2	Description
GSWB	No	No	Yes	Steel wire braided
ITC	No	Yes—②③		Instrumentation Tray Cable
ITC-HL	Yes—①②③	Yes—②③		Instrumentation Tray Cable—Hazardous area
LWA	No	No		Steel tape over lead sheath
MC	No	Yes—③	No	Interlocked armor—metal clad
MC-HL	Yes—①②③	Yes—②③	No	Interlocked armor—Hazardous location
MI	Yes	Yes	?	Mineral Insulated Cable
MV	No	Yes—②③		Medium voltage
PLTC	No	Yes—③		Power Limited Tray Cable
STA	No	No	Yes	Steel tape over inner jacket
SWA	No	No	Yes	Steel (served) wire—armored
TC	No	Yes—③	Yes?	Tray cable—unarmored
TECK	No—④	No—④	?	Interlocked armor—metal clad
Nonarmored Cables	No	No	Yes*	Single sheath with cable gland—“e” and IP 54

- ①—must be listed for area
- ②—see NEC® 501-4 for required conditions
- ③—requires approved termination fittings
- ④—approved for use in Canada per 1998 CEC

‡North American and European electrical systems are based on different voltages, frequencies and conductor sizes, making direct cable comparisons difficult if not impossible. Even though efforts are being made, at present there are no IEC cable standards that are accepted worldwide. Acceptable cables can vary country by country and project by project.

The above chart must be used in conjunction with Article 500 of the 1999 NEC. Many cables have restrictions which must be considered when using them.

In using cables in IEC Zone 1 and 2 areas particular attention must be taken to insure use of the proper cable gland and termination method.

# CHARTS COMPARING IEC vs NEC®/CEC

## CHART 1 AREA CLASSIFICATION—IEC vs NEC®/CEC (CLASS/DIVISION/GROUP)

Inflammable material	IEC/CENELEC				NEC®/CEC		
	Protection	Zone	Group	Subdivision	Class	Division	Group
<b>Gases and vapors</b>							
Acetylene	d and/or e	1 or 2	II	C	I	1 or 2	A
Hydrogen	d and/or e	1 or 2	II	C + H <sub>2</sub>	I	1 or 2	B
Propylene oxide Ethyl oxide Butadiene	d and/or e	1 or 2	II	B	I	1 or 2	B
Cyclopropane Ethyl ether Ethylene	d and/or e	1 or 2	II	B	I	1 or 2	C
Acetone Benzene Butane Propane Hexane Paint solvents Natural gas	d and/or e	1 or 2	II	A	I	1 or 2	D

## CHART 2 IEC vs NEC® TEMPERATURE CLASSIFICATION COMPARISON

Temperatures in °C	Classification	
	IEC	North America
85	T6	T6
100	T5	T5
120	T4	T4A
135	T4	T4
160	T3	T3C
165	T3	T3B
180	T3	T3A
200	T3	T3
215	T2	T2D
230	T2	T2C
260	T2	T2B
280	T2	T2A
300	T2	T2
450	T1	T1

## CHART 3 SAFE EQUIPMENT OPERATING TEMPERATURE

Spontaneous ignition temperature of the gases (T°)	Temperature class of the equipment					
	T6 (85°)	T5 (100°)	T4 (135°)	T3 (200°)	T2 (300°)	T1 (450°)
85° ≤ T° ≤ 100°	Yellow	Red	Red	Red	Red	Red
100° < T° ≤ 135°	Yellow	Yellow	Red	Red	Red	Red
135° < T° ≤ 200°	Yellow	Yellow	Yellow	Red	Red	Red
200° < T° ≤ 300°	Yellow	Yellow	Yellow	Yellow	Red	Red
300° < T° ≤ 450°	Yellow	Yellow	Yellow	Yellow	Yellow	Red
450° < T°	Yellow	Yellow	Yellow	Yellow	Yellow	Yellow

Note: the temperatures given in °C.



*Explosion Danger*



*Equipment Safe to Use*

# UNDERSTANDING IEC MARKINGS

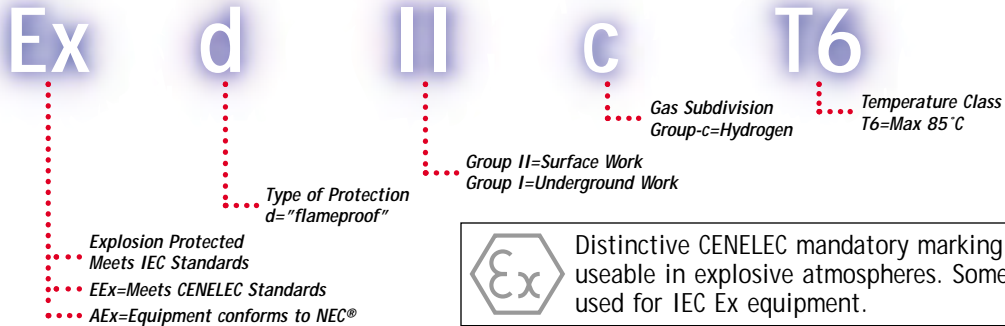

## MAIN IEC PROTECTION TECHNIQUES

### FLAMEPROOF "d"

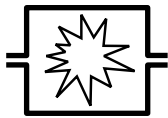

- **ZONE 1**
- Contain internal explosion
- Control external temperature of enclosure
- Similar to NEC® explosion proof

### INCREASED SAFETY "e"

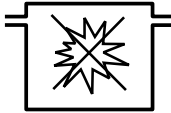

- **ZONE 1**
- High impact resistant enclosures—FRP, GRP, sheet steel/aluminum
- Will not hold static charge
- Use approved components
- Control internal and external temperature
- Maintain minimum of IP 54 ingress protection
- No arcs, no sparks

### FLAMEPROOF PLUS INCREASED SAFETY "de"

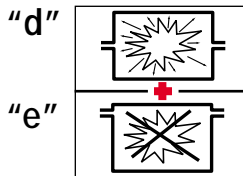

- **ZONE 1**
- Location of arcing has "d" protection (flameproof)
- Connection terminals have "e" protection (increased safety)
- Typical use in switches, lighting, power outlets—where arcs can normally occur
- Control internal and external temperature

### NON-SPARKING "n"

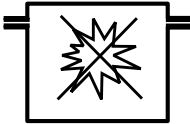

- **ZONE 2**
- Equipment has no normally arcing parts
- Thermal effects incapable of ignition
- nA=non sparking
- nR=restricted breathing
- nC=hermetically sealed non incensive

### PRESSURIZED APPARATUS "p"



- **ZONE 1**
- Expels ignitable vapor/gas
- Maintains positive enclosure pressure

### INTRINSIC SAFETY "ia"-"ib"

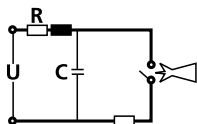

- **ia ZONE 0 & 1**
- **ib ZONE 1**
- Incapable of releasing enough energy to cause an explosion



# CHARTS COMPARING IEC vs NEC®/CEC

### CHART 4 IEC-NEC® GAS GROUPS

IEC	NEC®/ CEC	Gas or vapor
II C	A	Acetylene
II C	B	Hydrogen
II B	C	Ethylene
II B	C	Ethyl ether
II B	C	Cyclopropane
II B	C	Butadiene 1-3
II A	D	Propane
II A	D	Ethane
II A	D	Butane
II A	D	Benzene
II A	D	Pentane
II A	D	Heptane
II A	D	Acetone
II A	D	Methyl ethyl
II A	D	Methyl alcohol
II A	D	Ethyl alcohol

### CHART 5 IEC/NEC® EQUIPMENT STANDARDS

Equipment	IEC	CENELEC	NEC® (UL)	CEC (CSA)		
Fixed luminaires for general use	<ul style="list-style-type: none"> <li>• 60 079.0</li> <li>• 60 079.1</li> <li>• 60 079.7</li> <li>• 60 598.1</li> </ul>	<ul style="list-style-type: none"> <li>• EN 50 014</li> <li>• EN 50 018</li> <li>and/or 50 019</li> <li>• EN 60 598.1</li> </ul>	• UL 844	• C22.2 No. 4		
Portable equipment			<ul style="list-style-type: none"> <li>• UL 844</li> <li>• UL 781</li> </ul>	<ul style="list-style-type: none"> <li>• C22.2 No. 4</li> <li>• C22.2 No. 137</li> </ul>		
Floodlights and lamps			<ul style="list-style-type: none"> <li>• UL 844</li> <li>• UL 783</li> </ul>	<ul style="list-style-type: none"> <li>• C22.2 No. 4</li> <li>• C22.2 No. 137</li> </ul>		
Luminaires with fluorescent lamps			<ul style="list-style-type: none"> <li>• UL 844</li> <li>• UL 1570</li> </ul>	<ul style="list-style-type: none"> <li>• C22.2 No. 4</li> <li>• C22.2 No. 137</li> </ul>		
Luminaires with incandescent lamps			<ul style="list-style-type: none"> <li>• UL 844</li> <li>• UL 1571</li> </ul>	<ul style="list-style-type: none"> <li>• C22.2 No. 4</li> <li>• C22.2 No. 9</li> </ul>		
Power outlets			<ul style="list-style-type: none"> <li>• 60 079.0</li> <li>• 60 079.1</li> <li>• 60 079.7</li> <li>• 60 309.1</li> <li>• 60 309.2</li> </ul>	<ul style="list-style-type: none"> <li>• EN 50 014</li> <li>• EN 50 018</li> <li>and/or 50 019</li> <li>• EN 60 309.1</li> <li>(EN 60 309.2)</li> </ul>	<ul style="list-style-type: none"> <li>• UL 1010</li> <li>• UL 1682</li> </ul>	<ul style="list-style-type: none"> <li>• C22.2 No. 159</li> <li>N/A</li> </ul>
Switches			<ul style="list-style-type: none"> <li>• 60 079.0</li> <li>• 60 079.1</li> <li>• 60 079.7</li> <li>• 60 947.1</li> <li>• 60 947.3</li> </ul>	<ul style="list-style-type: none"> <li>• EN 50 014</li> <li>• EN 50 018</li> <li>and/or 50 019</li> <li>• EN 60 947.1</li> <li>• EN 60 947.3</li> </ul>	<ul style="list-style-type: none"> <li>• UL 508</li> <li>• UL 98</li> <li>• UL 1087</li> <li>• UL 894</li> </ul>	<ul style="list-style-type: none"> <li>• C22.2</li> <li>N/A</li> <li>• C22.2 No. 5.2</li> <li>• C22.2 No. 25 &amp; 30</li> </ul>

### CHART 6—PROTECTION TECHNIQUES RECOGNIZED BY IEC, NEC® AND CEC

Protection method	Identification letters	Permitted in division	Permitted in zone	Principle
Flameproof	d	2	1 or 2	Containment
Intrinsic safety (zone 0)	ia	1 or 2	0, 1, 2	Energy limited
Intrinsic safety (zone 1)	ib	2	1 or 2	Energy limited
Pressurization	p	1 or 2	1 or 2	Expels vapors
Increased safety	e	2	1 or 2	No arcs
Immersed in oil	o	1 or 2	1 or 2	Arc immersion
Filled with powder/sand	q	2	1 or 2	Arc immersion
Encapsulated	m	2	1 or 2	Hermetic seal
Apparatus with "n" protection	n	2	2	No sparking



\* Includes non-sparking (nA), restricted breathing (nR), hermetically sealed non-incendive (nC).



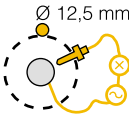

# UNDERSTANDING THE INGRESS PROTECTION SYSTEM

# IP

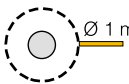
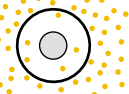
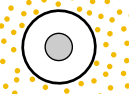
The IEC IP classification system designates the degree of protection provided by an enclosure against impact and/or water or dust penetration (ingress). It has two numbers; first—protection against solid objects, second protection against water.

## EXAMPLE: IP 54

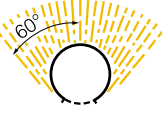
1st Figure: protection against solid bodies		
IP	TESTS	
0		No protection
1	 Ø 50 mm	Protected against solid bodies larger than 50mm (e.g. accidental contact with the hand)
2	 Ø 12,5 mm	Protected against solid bodies larger than 12.5mm (e.g. finger of the hand)
3	 Ø 2,5 mm	Protected against solid bodies larger than 2.5mm (tools, wires)
4	 Ø 1 mm	Protection against solid bodies larger than 1mm (fine tools, small wires)
5		Protected against dust (no harmful deposit)
6		Completely protected against dust

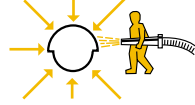
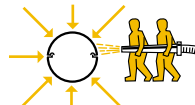
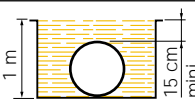
2nd Figure: protection against liquids		
IP	TESTS	
0		No protection
1		Protected against vertically-falling drops of water (condensation)
2	 15°	Protected against drops of water falling at up to 15° from the vertical
3	 60°	Protected against drops of rainwater at up to 60° from the vertical
4		Protected against projections of water from all directions
5		Protected against jets of water from all directions
6		Completely protected against jets of water of similar force to heavy seas
7	 1 m 15 cm mini	Protected against the effects of immersion

**IP RATINGS DO NOT INDICATE ANY DEGREE OF CORROSION RESISTANCE.**

Conversion of NEMA Enclosure Type numbers to IEC Classification Designations (Cannot be used to convert IEC Classification Designations to NEMA Type numbers)	
NEMA ENCLOSURE TYPE NUMBER	IEC ENCLOSURE CLASSIFICATION DESIGNATION
1	IP10
2	IP11
3	IP54
3R	IP54
3S	IP54
4 AND 4X	IP56
5	IP52
6 AND 6P	IP67
12 AND 12K	IP52
13	IP54

## TYPES OF PROTECTION

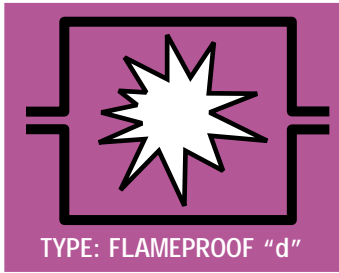

### REQUIREMENTS:

- Contain internal explosion
- Explosion cannot be transmitted outside enclosure
- External temperature of enclosure below ignition temperature of surrounding gases
- Similar to NEC® "explosion proof"
- Cable fittings must have 5 threads engaged
- Internal and external ground screw

### TYPICAL IEC FLAMEPROOF "d" EQUIPMENT



*Round junction box with cable glands*



*HPS floodlight*



*32 Amp 380v receptacle*



*Control station start-stop*

## TYPES OF PROTECTION

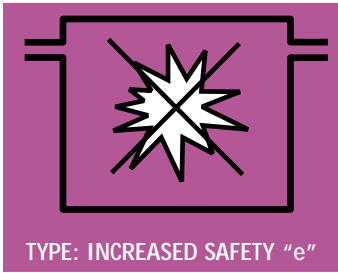

### REQUIREMENTS:

- Must use high impact resistant materials FRP, or GRP—will not hold static charge
- Cannot produce arcs or sparks
- Has special air and line leakage and creepage distances
- Use IEC non-loosen connection
- Minimum IP 54 ingress rating
- Control internal and external temperature. External should not exceed T-6 (85°C)

### TYPICAL IEC INCREASED SAFETY "e" EQUIPMENT



*Increased safety fixture 18, 36 or 58 watts*



*Round junction box with cable glands*



*16 amp, 24v receptacle*



*Control station, start-stop*

# INSTALLATION REQUIREMENTS FOR "e" EQUIPMENT

## JUNCTION BOX

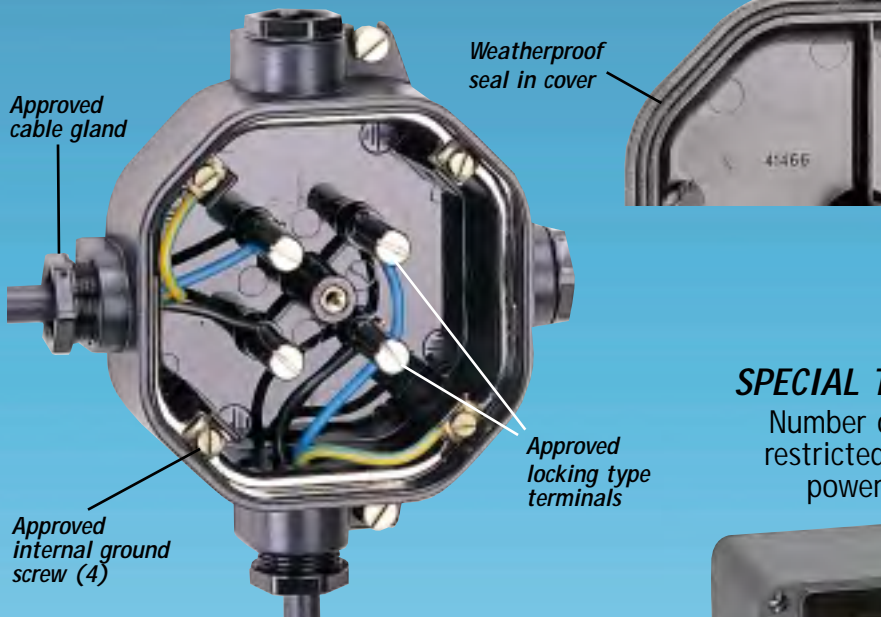

## SPECIAL TERMINAL BOX

Number of terminals is restricted by dissipated power per circuit



## STRIPPING A CONNECTION

The conductors

**CORRECT**

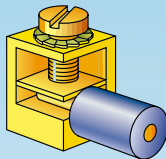

**INCORRECT**

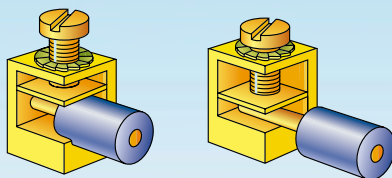

## TERMINAL LOCK

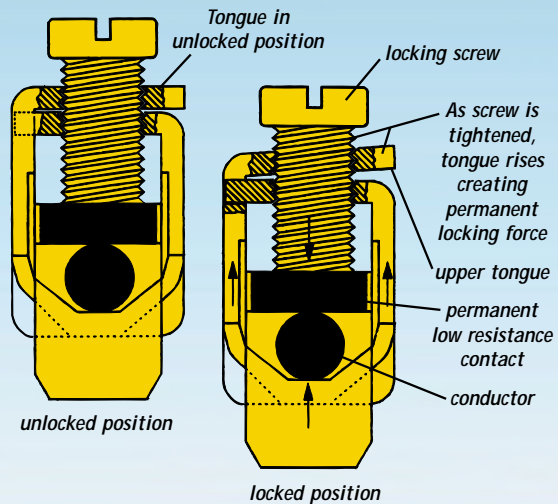



# TYPES OF PROTECTION

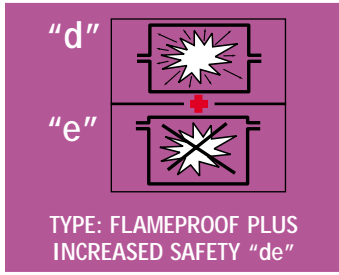

Items such as power outlets, switches, some lighting, etc., cannot be protected by "e" mode only. In this case "d" and "e" are combined.

## REQUIREMENTS:

- Area where arc can be produced is "d" or flameproof in a restricted volume enclosure
- Area with connection terminals is "e" or increased safety

## TYPICAL IEC INCREASED SAFETY "de" OR "ed" EQUIPMENT

*Typical "de" lighting fixture*

"d" Flameproof construction

*Typical "ed" receptacle*

"d"-First flameproof chamber-simultaneous disconnect of each phase

"d"-Second flameproof chamber pins disengage after power disconnection

*Non loosen terminals*

Ground terminals (2)

Increased safety "e" terminal box

Cable entries

*Close up of "e" connection chamber with required non loosen terminals*

*"de"=main protection is "d", but "e" is also present*

*"ed"=main protection is "e", but "d" is also present*

# TYPES OF PROTECTION

## TYPICAL IEC RESTRICTED BREATHING "n" EQUIPMENT

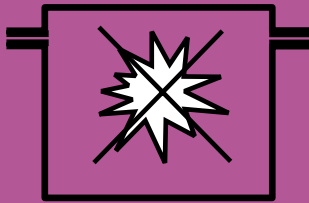

TYPE: nR RESTRICTED BREATHING

### REQUIREMENTS:

- Equipment has no normally arcing parts
- Enclosure restricts ingress of hazardous gases
- Thermal effects incapable of ignition
- nA=non sparking construction
- nR=restricted breathing
- nC=hermetically sealed, non incensive



Mercmaster III

Areamaster

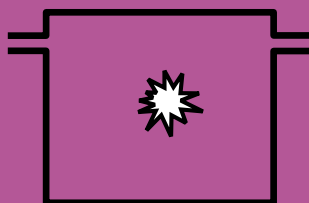

TYPE: INTRINSICALLY SAFE  
"ia" ZONE 0  
"ib" ZONE 1

### REQUIREMENTS:

- Install in safe areas (non IS), or in an approved "d" enclosure
- Energy limiting barriers
- Transmits signal from hazardous area (IS)
- Prevents energy release
- Ensure isolation of circuits between IS and non IS areas

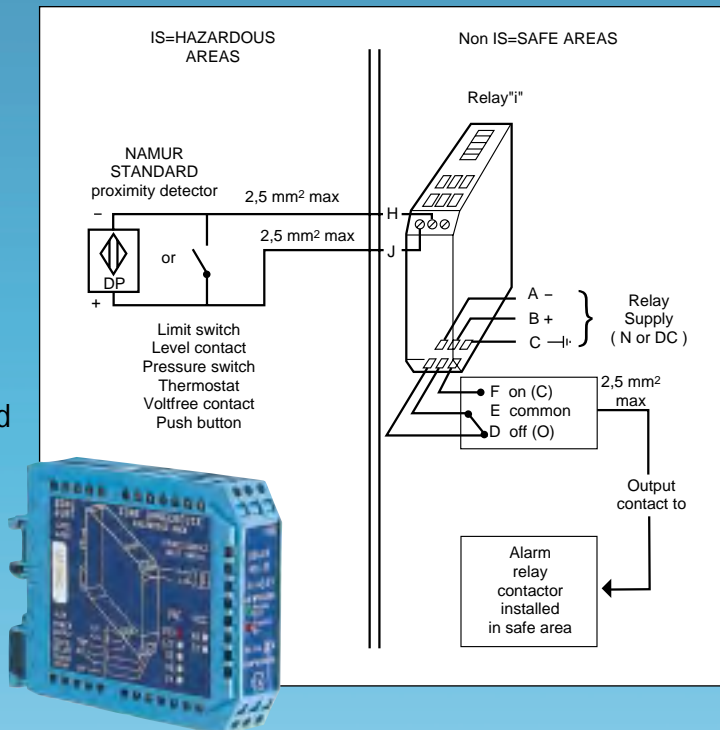

## MISCELLANEOUS NOTES

- IEC zone wiring methods prohibit use of twist-on (Wirenut®) connectors in Zone 1. Connections must be made to “increased safety” terminals. Twist-on connections are approved in NEC® Zone 1 and Zone 2 areas.
- NEC® allows choice of Class/Division or Zone method (with some restrictions) for new and add-on construction. The 1998 CEC requires Zone method classification only for all new and add-on construction. Local authorities can make exceptions allowing the Class/Division method.
- Equipment made to NEC®/UL requirements for Class/Division (Article 500-Class I) is automatically suitable for use in NEC® Zones as described in Article 505. See “Where to Use” chart below.
- Equipment made specifically using zone protection techniques, “d”, “p”, “ia or ib”, “n”, “o”, “e”, “m” and “q” and to be installed per NEC® Article 505, must be marked with symbol AEx.
- Equipment made and marked as, EEx, or Ex is not approved for use where NEC® jurisdiction is in place.
- The primary wiring method of NEC® is conduit. The primary wiring method of IEC is cable. IEC cables are generally not “rated” as to their suitability for use in hazardous areas. However IEC cable glands (connectors) are so rated. Cable and connectors used in NEC® Classified areas must be approved for the specific area where used.

Simplified...Where to Use Chart	
Equipment listed/marked for:	Use—as Noted
NEC® Class I, Div. 1	<u>OK</u> for use in NEC® Class I, Zone 1 and 2
NEC® Class I, Div. 2	<u>OK</u> for use in NEC® Class I, Zone 2
NEC® Class I, Zone 1	<u>NOT OK</u> for use in NEC® Class I, Div. 1
NEC® Class I, Zone 2	<u>OK</u> for use in NEC® Class I, Div. 2
NEC® AEx	<u>OK</u> for NEC® Zone 0, 1, 2 as marked
NEC® AEx	<u>NOT</u> suitable for NEC® Class I, Div. 1
NEC® AEx	<u>OK</u> for use in NEC® Class I, Div. 2
IEC Zone 1	<u>NOT</u> suitable for any NEC® area
IEC Zone 2	<u>NOT</u> suitable for any NEC area
IEC EEx or Ex	<u>NOT</u> suitable for any NEC® area

## SUMMARY

*Comparing the two different systems for classifying hazardous locations is not easily accomplished. They are both good systems and were developed independently of each other. Each has its own approach to area classification and each has its own advocates and approval organizations. Neither system has been proven to be safer than the other. Generally, cost comparisons of the two are inconclusive. Currently the IEC system has wide use throughout most of the world (except in the U.S.) in the chemical and petrochemical industries. With oil activity in scores of different countries, the IEC standardized approach suits these industries well.*

*The Class/Division method is the dominant method used in the U.S. and via the NEC® is meant to serve all hazardous areas from oil to sewage treatment to paint spray locations to everyday gas stations. The Class/Division method is very straightforward, leaves little doubt as to a classification and what electrical material can or cannot be used. Learning the IEC method is not as easy, but probably offers more choices as how to handle a particular application.*

*We wish to thank our affiliate company A.T.X. of Amiens, France for their help in supplying data on the IEC “system” and products. A.T.X. is a full line manufacturer of quality products for IEC applications worldwide.*

®Wirenut is a registered trademark of Ideal Industries Inc.

## GLOSSARY

- **AEx** – symbol designates equipment built to NEC® standards for use in NEC® Zone designated areas. Such products are not suitable for use in EEx or Ex European Zone areas.
- **Cable Gland** – term used internationally to describe a variety of products used for cable terminating in IEC systems. Available for armored and unarmored cable, and for “d” and “e” protection methods.
- **Cable Seal, Explosion Proof** – a terminator for cable that when used in Class I, Div. 1 and 2 areas, is filled with compound or epoxy to contain or minimize the passage of vapors/gases through cable from one location to another. Traditionally a product for NEC® applications.
- **CEC** – Canadian Electric Code
- **CENELEC** – European Committee for Electrical Standardization. Group of 19 European countries and 11 affiliated countries that have CENELEC standards based on the parallel working IEC/CENELEC.
- **“d” protection** – similar to “explosion proof”, contains explosion, external temperature limited.
- **“de” or “ed” protection** – protection combining “d” and “e” techniques.
- **Divisions** – term used in US NEC® to describe condition, frequency or duration where an explosive or flammable substance is present.
- **“e” protection** – control of internal and external temperatures. Normally sparking components excluded.
- **EEx** – designation for equipment complying with CENELEC standards.
- **Encapsulation—“m” protection**—parts that could ignite an explosive atmosphere are enclosed in an encapsulant preventing exposure to the explosive atmosphere.
- **Ex** – designation for hazardous location equipment complying to IEC standards or non CENELEC standards.
- **Flameproof** – an IEC or European term using “containment” protection. Similar to, but not exactly the same as US “explosion proof”.
- **Hazardous Location** – an area where potentially explosive or combustible gases, dusts or flyings may occur.
- **Increased Safety—“e” protection** – explosion protection that does not produce arcs or sparks in normal service. Design gives security against excessive temperature and occurrence of sparks and arcs.
- **Intrinsic Safety** – a method of protection that limits the energy passing into hazardous areas utilizing safety barriers. Regardless of fault in hazardous area, energy to ignite an explosive atmosphere cannot be released.
- **Intrinsic Safety—“i” protection** – refers to an electrical system that uses only intrinsically safe equipment (wiring, circuits, apparatus) that is incapable of causing ignition to a surrounding hazardous atmosphere.
- **IP** – Ingress Protection System used by IEC and CENELEC. Similar to but not same as US NEMA enclosure ratings. Two numbers used, first number rates protections against solid bodies ingress. second number protection against liquid ingress.
- **NEC®** – National Electric Code
- **Restricted Breathing—“nR” protection** – is used extensively on lighting fixtures in IEC systems. Components can be tightly closed to prevent access of flammable atmosphere into internal parts. Operating temperatures are taken externally thus allowing fixture use in areas having low gas ignition temperatures.
- **Subdivision** – Zone system grouping of various gas/vapors roughly equal to NEC® “Group”.
- **Zone** – defines conditions under which explosive gases are present in an area. Zones are similar to divisions, but are generally based on length of time hazardous material may be present.



**EGS**

Electrical Group



**Appleton®**

## REGIONAL SALES OFFICES AND DISTRIBUTION CENTERS

---

### **ATLANTA – SALES OFFICE AND DISTRIBUTION CENTER**

3029 Kingston Ct.  
Norcross, GA 30071  
1-770-416-6160  
FAX 1-800-356-7073 or 1-770-416-6115

---

### **CHICAGO – SALES OFFICE**

7770 N. Frontage Rd.  
Skokie, IL 60077  
1-847-679-7800  
FAX 1-847-763-6012

---

### **DENVER – SALES OFFICE**

720 S. Colorado Blvd., Suite 944S  
Denver, CO 80246  
1-303-758-5530  
FAX 1-800-356-8128 or 1-303-758-5627

---

### **DETROIT – SALES OFFICE**

Civic Center Office Plaza  
25882 Orchard Lake Rd., Suite 200B  
Farmington Hills, MI 48336  
1-248-888-0337  
FAX 1-800-356-4712 or 1-248-888-0341

---

### **HOUSTON – SALES OFFICE AND DISTRIBUTION CENTER**

13639 Aldine Westfield  
Houston, TX 77039  
1-281-590-9116  
FAX 1-281-590-4939

---

### **LOS ANGELES – SALES OFFICE AND DISTRIBUTION CENTER**

2330-B Artesia Ave.  
Fullerton, CA 92833  
1-714-525-7100  
FAX 1-800-356-8127 or 1-714-525-2927

---

### **NEW YORK – SALES OFFICE**

East Gate Center  
309 Fellowship Rd., 2nd Floor  
Mount Laurel, NJ 08054  
1-609-642-4024  
FAX 1-609-642-4025

---

### **OAKLAND – SALES OFFICE**

7700 Edgewater Dr., Suite 549  
Oakland, CA 94621-3092  
1-510-636-2080  
FAX 1-510-636-2089

---

